

## WHAT TO REMEMBER WHEN INJECTING

Before you begin, ensure you have read all of the Patient Information Leaflet supplied with your Erelzi® pre-filled syringe.<sup>PIL,p1</sup> Before injecting, wash your hands well with soap and water.<sup>PIL,p14</sup> Using a circular motion, clean the injection site with an alcohol wipe.<sup>PIL,p19</sup> Leave it to dry before injecting.<sup>PIL,p19</sup> Do not touch the cleaned area before injecting.<sup>PIL,p19</sup>

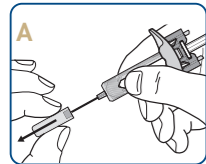

- Carefully pull the needle cap straight off to remove it from the syringe<sup>PIL,p15</sup> (see Figure A)
- Discard the needle cap<sup>PIL,p15</sup>
- You may see a drop of liquid at the end of the needle. This is normal<sup>PIL,p15</sup>

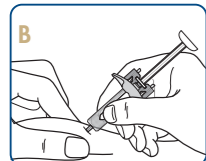

- Gently pinch the skin at the injection site<sup>PIL,p15</sup> (see Figure B)
- Insert the needle into your skin as shown<sup>PIL,p15</sup>
- Push the needle all the way in to ensure that the medication can be fully administered<sup>PIL,p15</sup>

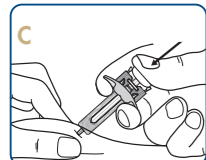

- Hold the syringe as shown. Slowly press the plunger as far as it will go, so that the plunger head is completely between the needle guard wings<sup>PIL,p15</sup> (see Figure C)
- Keep the plunger pressed fully down while you hold the syringe in place for 5 seconds<sup>PIL,p15</sup>

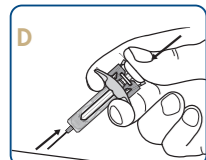

- Keep the plunger pressed fully down while you carefully lift the needle straight out from the injection site and let go of your skin<sup>PIL,p15</sup> (see Figure D)

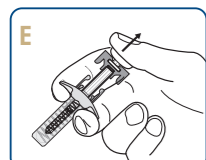

- Slowly release the plunger and allow the needle guard to cover the exposed needle<sup>PIL,p16</sup> (see Figure E)
- There may be a small amount of blood at the injection site.<sup>PIL,p16</sup> You can press a cotton ball or gauze onto the injection site and hold it for 10 seconds.<sup>PIL,p16</sup> Do not rub the injection site.<sup>PIL,p16</sup> You may cover the injection site with a small adhesive bandage, if needed<sup>PIL,p16</sup>

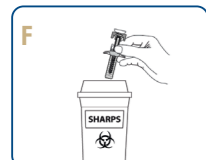

- Dispose of the used syringe in a sharps container.<sup>PIL,p16</sup> For your safety and health and that of others, needles and used syringes must never be re-used<sup>PIL,p16</sup> (see Figure F)
- Do not throw away any medicines via wastewater or household waste.<sup>PIL,p11</sup> Ask your doctor or pharmacist how to throw away medicines you no longer use<sup>PIL,p11</sup>

The syringe has a needle guard that will be activated to automatically cover the needle after the injection has finished.<sup>PIL,p13,p16</sup> If you press down the plunger as far as it will go to fully deliver your injection, the needle guard will activate after the injection has finished<sup>PIL,p15</sup> and the plunger is released.<sup>PIL,p16</sup>

## YOU ARE NOT ALONE

For more information and support please contact your healthcare provider and/or patient support nurse. You can also email Sandoz at [medical.za@sandoz.com](mailto:medical.za@sandoz.com)

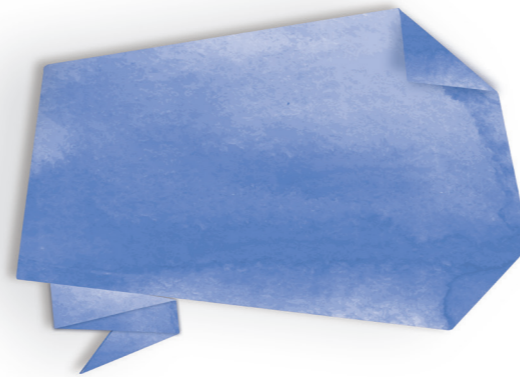

Insert QR code  
when supplied

Scan here to watch a self-injection demonstration video.

**SANDOZ** A Novartis  
Division

[S4] ERELZI® 25 mg (solution for injection). Reg. No.: 55/3.1/0392. Composition: Each pre-filled syringe contains 25 mg etanercept. [S4] ERELZI® 50 mg (solution for injection). Reg. No.: 55/3.1/0393. Composition: Each pre-filled syringe/pen contains 50 mg etanercept. Pharmacological Classification: A3.1 Anti-rheumatics (anti-inflammatory agents). For full prescribing information refer to the Sandoz Professional Information approved by the South African Health Products Regulatory Authority (SAHPRA).

Sandoz SA (Pty) Ltd, Reg. No. 1990/001979/07, Magwa Crescent West, Waterfall City, Jukskei View, Midrand, 2090. Tel: +27 (11) 347 6600. SANCAL Customer Call Centre: 0861 726 225. Reporting of AEs: <https://www.report.novartis.com> SAN.ERZ.2022.07.15

Reference: 1. Sandoz SA (Pty) Ltd. ERELZI®. Patient information leaflet. 26 January 2022.

**SANDOZ** A Novartis  
Division



**ERELZI® (ETANERCEPT)  
PRE-FILLED SYRINGE**

SELF-INJECTION GUIDE

## INJECTING WITH THE ERELZI® PRE-FILLED SYRINGE

It is important not to try to inject yourself until you have been trained by your doctor, nurse or pharmacist.<sup>PIL,p12</sup>

Read these instructions *before* injecting,<sup>PIL,p12</sup> as well as the Patient Information Leaflet provided with Erelzi®.<sup>PIL</sup> They will help you to inject correctly using the Erelzi® pre-filled syringe.<sup>PIL,p16</sup>

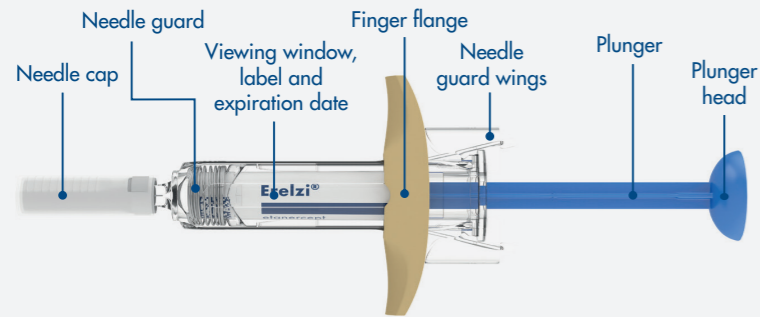

PIL,p13

### It is important that you:

- **Do not open** the outer box until you are ready to use the syringe.<sup>PIL,p13</sup>
- Store your outer carton of syringes in a refrigerator, between 2°C and 8°C.<sup>PIL,p11</sup>
- **Do not use** the syringe if the seals of the blister are broken, as it may not be safe for you to use.<sup>PIL,p13</sup>
- **Never leave** the syringe unattended where others might tamper with it.<sup>PIL,p13</sup>
- **Do not shake** the syringe.<sup>PIL,p13</sup>
- **Do not remove** the needle cap until just before you give the injection.<sup>PIL,p13</sup>
- If you drop your syringe, **do not use** it if it looks damaged, or if you dropped it with the needle cap removed.<sup>PIL,p17</sup>
- Be careful **not to touch** the needle guard wings before use.<sup>PIL,p13</sup> Touching them may cause the needle guard to be activated too early.<sup>PIL,p13</sup>
- **Throw away** the used syringe right after use.<sup>PIL,p13</sup> Do not throw away the used syringe with your household waste.<sup>PIL,p13</sup> **Do not re-use a syringe**

## WHAT YOU NEED

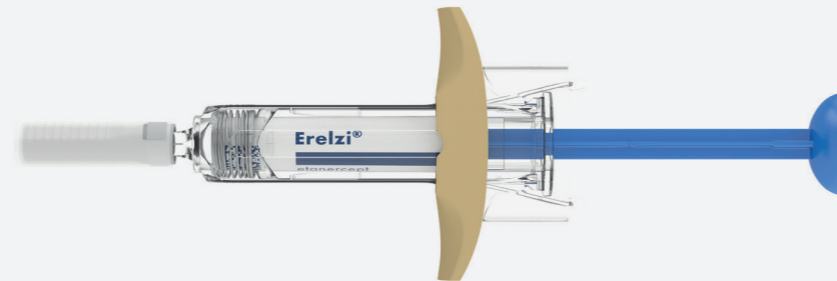

A new and unused Erelzi® pre-filled syringe

PIL,p12

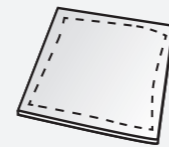

Alcohol swab  
(not included)

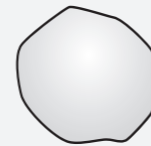

Cotton ball or gauze  
(not included)



Sharps disposal  
container  
(not included)

PIL,p13

## WHERE TO INJECT

- The recommended injection site is the front of your thighs.<sup>PIL,p14</sup> You may also use the lower abdomen, but not the area 5 cm around your navel (belly button).<sup>PIL,p14</sup>
- Choose a different site each time you give yourself an injection.<sup>PIL,p14</sup>
- Do not inject into areas where the skin is tender, bruised, red, scaly, or hard.<sup>PIL,p14</sup> Avoid areas with scars or stretch marks.<sup>PIL,p14</sup> If you have psoriasis, you should **NOT** inject directly into areas with psoriasis plaques.<sup>PIL,p14</sup>

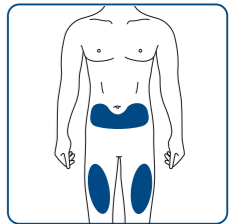

PIL,p14

### Before injecting

- For a more comfortable injection,<sup>PIL,p17</sup> take the blister containing the syringe out of the refrigerator and leave it unopened for 15 to 30 minutes so that it reaches room temperature.<sup>PIL,p14</sup>
- Take the syringe out of the blister.<sup>PIL,p14</sup>
- Look through the viewing window.<sup>PIL,p14</sup> The solution should be clear or slightly opalescent, colorless, or slightly yellowish.<sup>PIL,p14</sup> It may contain small white or almost transparent particles of protein.<sup>PIL,p14</sup> Do not use the solution if it is discolored, cloudy, or if particles other than those described above are present.<sup>PIL,p15</sup>
- Do not use the syringe if it is broken or the needle guard is activated.<sup>PIL,p12&p15</sup>
- Look at the expiration date (EXP) on your syringe.<sup>PIL,p11</sup> Do not use the syringe if the expiration date has passed.<sup>PIL,p11</sup>